

**BALL

The Ball is one of the best-known traditional origamis. Nobody knows when it was invented, but it was a long time ago.

YOU NEED

A square of paper, about 8" (20 cm)

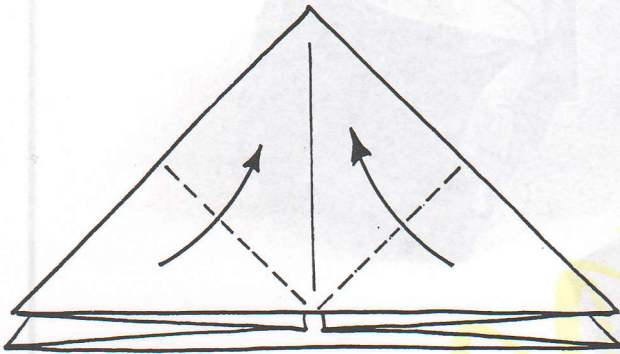

1. Begin with the Triangle Base (page 42). On the front flaps only, fold the outside corners of the triangle up to the top corner. Flip the paper over and repeat the same on the back.

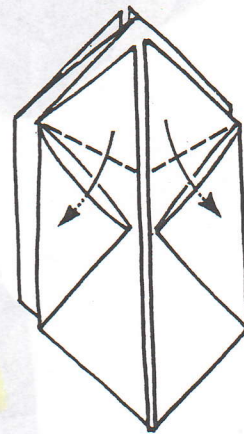

3. With the last step you made little pockets. Slide the loose points at the top into the pockets as far as you can. Repeat on the back.

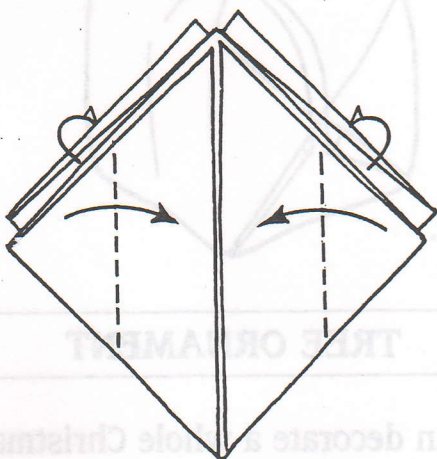

2. On the front flap only, fold the outside corners to the middle. Repeat on the back.

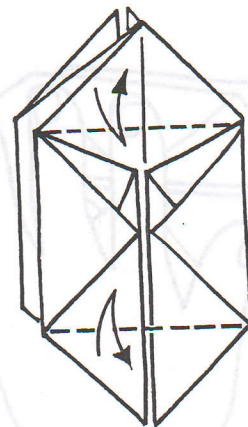

4. Fold back and forth on the broken lines. The Ball looks the same as before, but the lines help to give a better shape to the Ball later on.

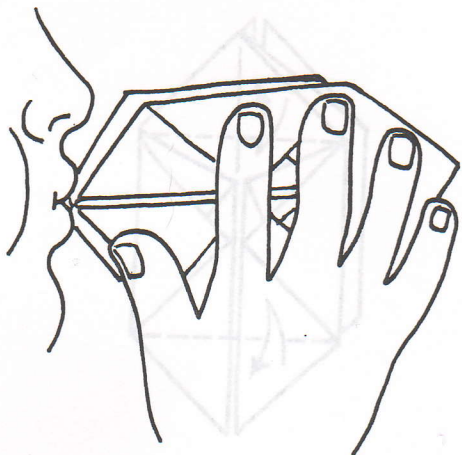
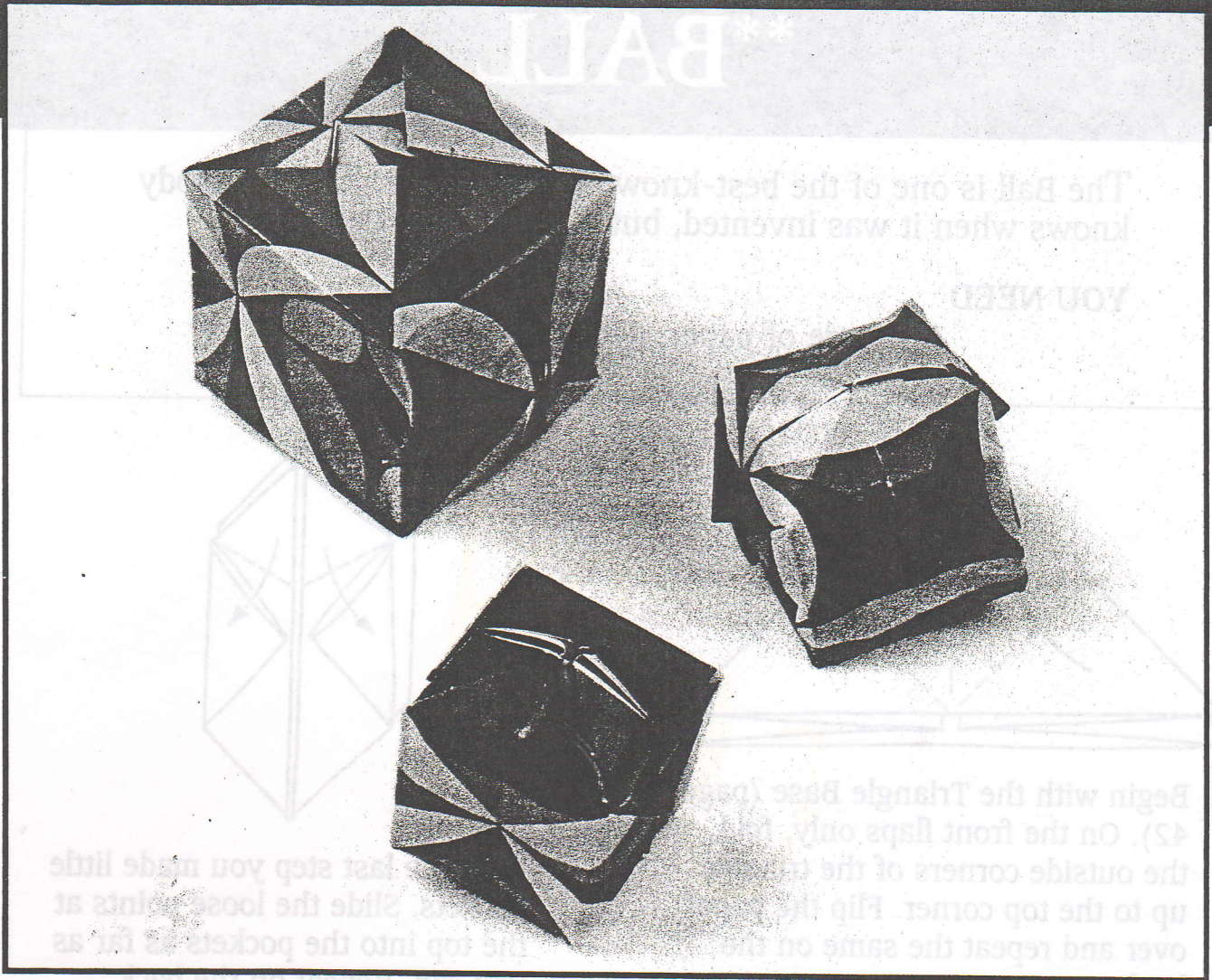

- Place the Ball lightly between both hands. Blow into the hole that is at one end of the Ball.

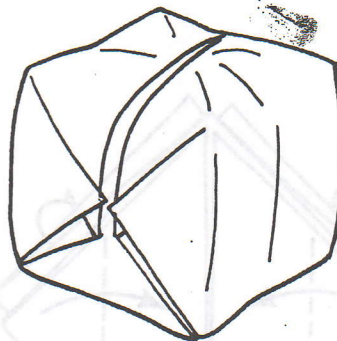

6. Ball.

TREE ORNAMENT

You can decorate a whole Christmas tree with paper Balls, small and large, in many colors. Flatten them and store them in a box for next year.